

Safety

The Rules of the Air Regulations 2015

Last uploaded 09 February 2022

PLEASE NOTE there is an index with hyperlinks at the end of this document

Terms of Use

1. Permitted Use

You may, in the ordinary course of your business and subject to the restrictions in clause 2:

(a) view, copy (download and/or print), customise and use the Regulations reproduced on this website (the “Content”).

(b) Distribute and redistribute portions of the Content which: (a) have no independent commercial value; and (b) could not be used as a substitute for any service (or a substantial part of it) in a non-Systematic manner (i.e. on an infrequent basis and not automatically generated by machine or regularly created by individual users).

2. Restrictions on Use

You may not:

(a) modify or make alterations, additions or amendments to the Content;

(b) use all or some of the Content to create or allow others to create derivative databases or in any other product or service, or in other works except in documents, memoranda, advices, briefs and other similar materials whether in print or electronic form created in the regular course of your business.

3. Attribution

All copyright notices must be retained and all Content shall include the following attribution language: “Reprinted from Westlaw Edge UK with permission of Thomson Reuters”.

2015 No. 840

CIVIL AVIATION

The Rules of the Air Regulations 2015

Thomson Reuters (Legal) Limited.

UK Statutory Instruments Crown Copyright. Reproduced by permission of the Controller of Her Majesty's Stationery Office.

Made

17th March 2015

Coming into force

30th April 2015

The Secretary of State, in exercise of the powers conferred by article 160(1) of the Air Navigation Order 2009¹, makes the following Regulations.

Notes

¹ Amended by S.I. 2014/3302. There are other amendments to the Order but none is relevant.

Extent

Preamble: United Kingdom

 Law In Force

1. Citation and commencement

These Regulations may be cited as the Rules of the Air Regulations 2015 and come into force on 30th April 2015.

Commencement

reg. 1: April 30, 2015

Extent

reg. 1: United Kingdom

 Law In Force

2. Rules of the Air

The Rules of the Air in Schedule 1 have effect and may be cited as the Rules of the Air 2015.

Commencement

reg. 2: April 30, 2015

Extent

reg. 2: United Kingdom

 Law In Force

3.— Review

- (1) The Secretary of State must from time to time—
 - (a) carry out a review of the Rules in Schedule 1 to these Regulations;
 - (b) set out the conclusions of the review in a report; and
 - (c) publish the report.
 - (2) The report must in particular—
 - (a) set out the objectives to be achieved by the Rules;
 - (b) assess the extent to which those objectives have been achieved; and
 - (c) assess whether those objectives remain appropriate and, if so, the extent to which they could be achieved by a system of lesser regulation.
 - (3) The first report under this regulation must be published before 30th April 2020.
 - (4) Reports under this regulation are to be published at intervals not exceeding five years.
-

Commencement

reg. 3(1)-(4): April 30, 2015

Extent

reg. 3(1)-(4): United Kingdom

 Law In Force

4. Revocation

The Regulations listed in Schedule 2 are revoked.

Commencement

reg. 4: April 30, 2015

Extent

reg. 4: United Kingdom

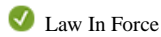

Law In Force

Signed by authority of the secretary of State

Robert Goodwill
Parliamentary Under Secretary of State
Department for Transport

17th March 2015

SCHEDULE 1

The Rules of the Air Regulations 2015

Regulation 2

SECTION 1

INTERPRETATION

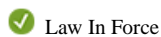

Law In Force

1. Interpretation

(1) In these Rules “anti-collision light” means—

(a) in relation to rotorcraft, a flashing red light; and

(b) in relation to any other aircraft, a flashing red or flashing white light,

in either case showing in all directions.

(2) Subject to paragraph (3), terms used in these Rules which are defined in article 2 of the Standardised European Rules of the Air Regulation¹ have the same meaning as given in that article.

(3) The term “aerodrome traffic zone” has the same meaning as given in [article 5 of the Air Navigation Order 2016]².

(4) References in these Rules to “SERA” followed by a number refer to the provision with the corresponding number in SERA³.

Notes

¹ Commission Implementing Regulation (EU) No. 923/2012 of the European Parliament and of the Council of 26 September 2012 laying down the common rules of the air and operational provisions regarding services and procedures in air navigation and amending Implementing Regulation (EU) No 1035/2011 and Regulations (EC) No 1265/2007, (EC) No 1794/2006, (EC) No 730/2006, (EC) No 1033/2006 and (EU) No 255/2010 (O.J. No.L281 of 13.10.2012, p.1).

² Words substituted by Air Navigation Order 2016/765 Sch.14(2)(2)(1) para.9(a) (August 25, 2016: substitution has effect subject to savings specified in SI 2016/765 reg.274)

³ The definition of the term “SERA” was inserted into article 255(1) of the Air Navigation Order 2009 by article 76 of S.I. 2014/3302 and means the Annex to the Standardised European Rules of the Air Regulation.

Commencement

Sch. 1(1) para. 1(1)-(4): April 30, 2015

Extent

Sch. 1(1) para. 1(1)-(4): United Kingdom

SECTION 2**APPLICATION AND COMPLIANCE**

 Law In Force

2. Application of Rules to aircraft

Subject to rule 6 and to [articles 249(3) and 22(1) of the Air Navigation Order 2016]¹ and insofar as these Rules apply to aircraft they apply—

- (a) to all aircraft within the United Kingdom; and
 - (b) to all aircraft registered in the United Kingdom, wherever they may be².
-

Notes

¹ Words substituted by Air Navigation Order 2016/765 Sch.14(2)(2)(1) para.9(b) (August 25, 2016: substitution has effect subject to savings specified in SI 2016/765 reg.274)

² Article 160(3) of the Air Navigation Order 2009 provides that it is lawful for any of the Rules of the Air to be departed from to the extent necessary for avoiding immediate danger, complying with the law of any country other than the United Kingdom within which the aircraft then is or for complying with Military Flying Regulations or Flying Orders to Contractors issued by the Secretary of State. Article 252(1) of the Air Navigation Order 2009 provides that nothing in the Order applies to military aircraft apart from certain specified articles, including article 160(1)(a). A “military aircraft” is defined in article 255(1) of the Air Navigation Order 2009.

Commencement

Sch. 1(2) para. 2(a)-(b): April 30, 2015

Extent

Sch. 1(2) para. 2(a)-(b): United Kingdom

 Law In Force

3. Permissions

Wherever in these Rules there is provision for a permission to be granted by the CAA¹ for the purposes of a rule, it may be granted—

- (a) in respect of classes of aircraft, persons or vehicles generally or in respect of any particular aircraft, person or vehicle or class of aircraft, person or vehicle; and
- (b) subject to such conditions as the CAA thinks fit.

Notes

- ¹ The CAA is a body corporate, called the Civil Aviation Authority, constituted under section 2 of the Civil Aviation Act 1982 (c.16). Section 2 is amended by section 95 of the Civil Aviation Act 2012 (c.19).

Commencement

Sch. 1(2) para. 3(a)-(b): April 30, 2015

Extent

Sch. 1(2) para. 3(a)-(b): United Kingdom

SECTION 3**GENERAL RULES, COLLISION AVOIDANCE AND PROTECTION OF PERSONS AND PROPERTY**

✓ Law In Force

4. Aerobatic flights

Aerobatic flight is not permitted—

- (a) over the congested area of any city, town or settlement; or
- (b) within notified controlled airspace¹ other than with the consent of the air traffic control unit notified as serving that airspace.

Notes

- ¹ “Notified” and “controlled airspace” are defined in article 255(1) of the Air Navigation Order 2009. The classification of airspace in the United Kingdom is notified in the Aeronautical Information Publication which is published by the CAA.

Commencement

Sch. 1(3) para. 4(a)-(b): April 30, 2015

Extent

Sch. 1(3) para. 4(a)-(b): United Kingdom

✓ Law In Force

5.— Landing and taking off within congested areas and near open-air assemblies

- (1) An aircraft must not take off or land within a congested area of any city, town or settlement except—
- (a) at an aerodrome in accordance with procedures notified by the CAA; or

(b) at a landing site which is not an aerodrome in accordance with the permission of the CAA.

(2) An aircraft must not land or take-off within 1,000 metres of an open-air assembly of more than 1,000 persons except—

- (a) at an aerodrome in accordance with procedures notified by the CAA; or
- (b) at a landing site which is not an aerodrome in accordance with procedures notified by the CAA and with the written permission of the organiser of the assembly.

Commencement

Sch. 1(3) para. 5(1)-(2)(b): April 30, 2015

Extent

Sch. 1(3) para. 5(1)-(2)(b): United Kingdom

 Law In Force

6.— Test flying over congested areas

(1) Subject to paragraph (2), an aircraft to which this rule applies must not fly over a congested area of any city, town or settlement other than to the extent necessary in order to take off or land in accordance with normal aviation practice.

(2) Paragraph (1) does not apply if the CAA has given its written permission for the flight over the congested area.

(3) This rule applies to an aircraft that—

- (a) does not have a valid certificate of airworthiness in force; and
- (b) is flying for the purpose of—
 - (i) experimenting with or testing—
 - (aa) the aircraft; or
 - (bb) any engines or equipment installed or carried in the aircraft; or
 - (ii) enabling the aircraft to qualify for—
 - (aa) the issue or validation of a certificate of airworthiness;
 - (bb) the approval of a modification of the aircraft; or
 - (cc) the issue of a permit to fly.

Commencement

Sch. 1(3) para. 6(1)-(3)(b)(ii)(cc): April 30, 2015

Extent

Sch. 1(3) para. 6(1)-(3)(b)(ii)(cc): United Kingdom

✓ Law In Force

7.— Launching, picking up and dropping of tow ropes, etc.

(1) An aircraft must not take off from an aerodrome with tow ropes, banners or similar articles towed by it except in accordance with arrangements made with the air traffic control unit at the aerodrome or, if there is no such unit, the person in charge of the aerodrome.

(2) Tow ropes, banners or similar articles towed by aircraft must not be picked up by, or dropped from, an aircraft at an aerodrome except—

(a) in accordance with arrangements made with the air traffic control unit at the aerodrome or, if there is no such unit, with the person in charge of the aerodrome; or

(b) in the area designated by the marking described in rule 20(7), but only when the aircraft is flying in the direction appropriate for landing.

Commencement

Sch. 1(3) para. 7(1)-(2)(b): April 30, 2015

Extent

Sch. 1(3) para. 7(1)-(2)(b): United Kingdom

✓ Law In Force

8. Avoiding aerial collisions

For the purposes of SERA.3201, SERA.3205 and SERA.3210 a glider and a flying machine which is towing it are to be considered to be a single aircraft under the command of the commander of the flying machine.

Commencement

Sch. 1(3) para. 8: April 30, 2015

Extent

Sch. 1(3) para. 8: United Kingdom

✓ Law In Force

9.— Order of landing

(1) If an air traffic control unit has communicated to any aircraft an order of priority for landing, the aircraft must approach to land in that order.

(2) If the commander of an aircraft which has previously been given permission to land gives way to another aircraft that is making an emergency landing at night, that commander must not attempt to land until the commander has received further permission to do so.

Commencement

Sch. 1(3) para. 9(1)-(2): April 30, 2015

ExtentSch. 1(3) para. 9(1)-(2): United Kingdom

✔ Law In Force

10.— Landing and take-off

(1) Subject to paragraph (4), a flying machine or glider must not land on a runway at an aerodrome if there are other aircraft on the runway.

(2) If take-offs and landings are not confined to a runway—

(a) when landing, a flying machine or glider must leave clear on its left any aircraft which has landed, is already landing or is about to take off;

(b) a flying machine or glider which is about to turn must turn to the left if the commander of the aircraft is satisfied that such action will not interfere with other traffic movements; and

(c) a flying machine which is about to take off must take up position and manoeuvre in such a way as to leave clear on its left any aircraft which has already taken off or is about to take off.

(3) Subject to paragraph (4), a flying machine must move clear of the landing area as soon as it is possible to do so after landing.

(4) Paragraphs (1) and (3) do not apply if the air traffic control unit at the aerodrome otherwise authorises the flying machine or glider.

Commencement

Sch. 1(3) para. 10(1)-(4): April 30, 2015

ExtentSch. 1(3) para. 10(1)-(4): United Kingdom

✔ Law In Force

11.— Flight within aerodrome traffic zones

(1) This rule applies in relation to such aerodromes described in Column 1 of Table 1 as are notified for the purposes of this rule and at such times as are specified in Column 2 of the Table.

Table 1

<i>Table Column 1</i>	<i>Column 2</i>
(a) A Government aerodrome.	At such times as are notified.

Table Column 1**Column 2**

(b) An aerodrome having an air traffic control unit or flight information service centre.	During the notified hours of watch of the air traffic control unit or the flight information service centre.
---	--

(c) A national licensed aerodrome or an EASA certificated aerodrome having an air/ground communications service unit with aircraft.	During the notified hours of watch of the air/ground communications service unit.
---	---

(2) An aircraft must not fly, take off or land within the aerodrome traffic zone of an aerodrome unless the commander of the aircraft has complied with paragraphs (3), (4) or (5), as appropriate.

(3) If the aerodrome has an air traffic control unit the commander must obtain the permission of that unit to enable the flight to be conducted safely within the aerodrome traffic zone.

(4) If the aerodrome provides a flight information service the commander must obtain information from the flight information centre to enable the flight to be conducted safely within the aerodrome traffic zone.

(5) If there is no flight information centre at the aerodrome the commander must obtain information from the air/ground communication service to enable the flight to be conducted safely within the aerodrome traffic zone.

(6) The commander of an aircraft flying within the aerodrome traffic zone of an aerodrome must—

- (a) cause a continuous watch to be maintained on the appropriate radio frequency notified for communications at the aerodrome; or
- (b) if this is not possible, cause a watch to be kept for such instructions as may be issued by visual means; and
- (c) if the aircraft is fitted with means of communication by radio with the ground, communicate the aircraft's position and height to the air traffic control unit, the flight information centre or the air/ground communications service unit at the aerodrome (as the case may be) on entering the aerodrome traffic zone and immediately prior to leaving it.

Commencement

Sch. 1(3) para. 11(1)-(6)(c): April 30, 2015

Extent

Sch. 1(3) para. 11(1)-(6)(c): United Kingdom

 Law In Force

12.— Movement of aircraft on uncontrolled aerodromes

(1) An aircraft must not taxi on the apron or the manoeuvring area of an uncontrolled aerodrome without the permission of either—

- (a) the person in charge of the aerodrome; or
- (b) the flight information centre notified as being on watch at the aerodrome.

(2) In this rule “uncontrolled aerodrome” means an aerodrome at which no air traffic control service is provided to aerodrome traffic regardless of whether or not an air traffic zone exists.

Commencement

Sch. 1(3) para. 12(1)-(2): April 30, 2015

Extent

Sch. 1(3) para. 12(1)-(2): United Kingdom

✔ Law In Force

13.— Access to and movement of persons and vehicles on the aerodrome

- (1) Unless there is a public right of way over it, a person or vehicle must—
- (a) not go onto any part of an aerodrome without the permission of the person in charge of that part of the aerodrome; and
 - (b) comply with any conditions subject to which that permission may be granted.
- (2) A person or vehicle must—
- (a) not go onto or move on the manoeuvring area of an aerodrome which provides an air traffic control service or a flight information service without the permission of the person providing that service; and
 - (b) comply with any conditions subject to which that permission may be granted.
-

Commencement

Sch. 1(3) para. 13(1)-(2)(b): April 30, 2015

Extent

Sch. 1(3) para. 13(1)-(2)(b): United Kingdom

SECTION 4**LIGHTS TO BE DISPLAYED BY AIRCRAFT**

✔ Law In Force

14. Stationary helicopters on offshore or renewable energy installations

Notwithstanding SERA.3215 a helicopter may, when stationary on an offshore or renewable energy installation, switch off the red anti-collision light as long as that is done in accordance with a procedure contained in the operations manual of the helicopter operator as a signal to ground personnel that it is safe to approach the helicopter for the purpose of embarkation or disembarkation of passengers or the loading or unloading of cargo.

Commencement

Sch. 1(4) para. 14: April 30, 2015

Extent

Sch. 1(4) para. 14: United Kingdom

✔ Law In Force

15.— Failure of anti-collision and navigation lights

(1) If any light required to be displayed by SERA.3215 fails during flight at night and cannot be immediately repaired or replaced, the aircraft must land as soon as it can safely do so, unless authorised by the appropriate air traffic control unit to continue its flight.

(2) An aircraft may continue to fly during the day in the event of a failure of an anti-collision light provided the light is repaired at the earliest practicable opportunity.

Commencement

Sch. 1(4) para. 15(1)-(2): April 30, 2015

Extent

Sch. 1(4) para. 15(1)-(2): United Kingdom

✔ Law In Force

16.— Airships by day

(1) An airship flying during the day in any of the circumstances referred to in paragraph (2) must display two black balls suspended below the control car so that one is at least 4 metres above the other and at least 8 metres below the control car.

(2) The circumstances are that—

- (a) the airship is not under command;
- (b) the airship has voluntarily stopped its engines; or
- (c) the airship is being towed.

(3) For the purposes of this rule an airship is not under command when it is unable to execute a manoeuvre which it may be required to execute by these Rules.

Commencement

Sch. 1(4) para. 16(1)-(3): April 30, 2015

Extent

Sch. 1(4) para. 16(1)-(3): United Kingdom

SECTION 5

AERODROME VISUAL SIGNALS AND MARKINGS

✓ Law In Force

17. Aerodrome Visual Signals and Markings

Within the United Kingdom any signal or marking which is specified in these Rules and which is given or displayed—

(a) by any person in an aircraft;

(b) at an aerodrome; or

(c) at any other place which is being used by aircraft for landing or take-off,

has the meaning assigned to it by this section.

Commencement

Sch. 1(5) para. 17(a)-(c): April 30, 2015

Extent

Sch. 1(5) para. 17(a)-(c): United Kingdom

✓ Law In Force

18. Misuse of signals and markings

A person in an aircraft or on an aerodrome or at any place at which an aircraft is taking off or landing must not—

(a) make any signal which may be confused with a signal specified in SERA.3301 and Appendix 1 to SERA; or

(b) except with lawful authority, make any signal which the person knows or ought reasonably to know to be a signal in use for signalling to or from any of Her Majesty's naval, military or air force aircraft.

Commencement

Sch. 1(5) para. 18(a)-(b): April 30, 2015

Extent

Sch. 1(5) para. 18(a)-(b): United Kingdom

✓ Law In Force

19.— Markings for paved runways and taxiways

(1) Subject to paragraph (2), two yellow broken lines and two yellow continuous lines, as illustrated in the diagrams in this paragraph—

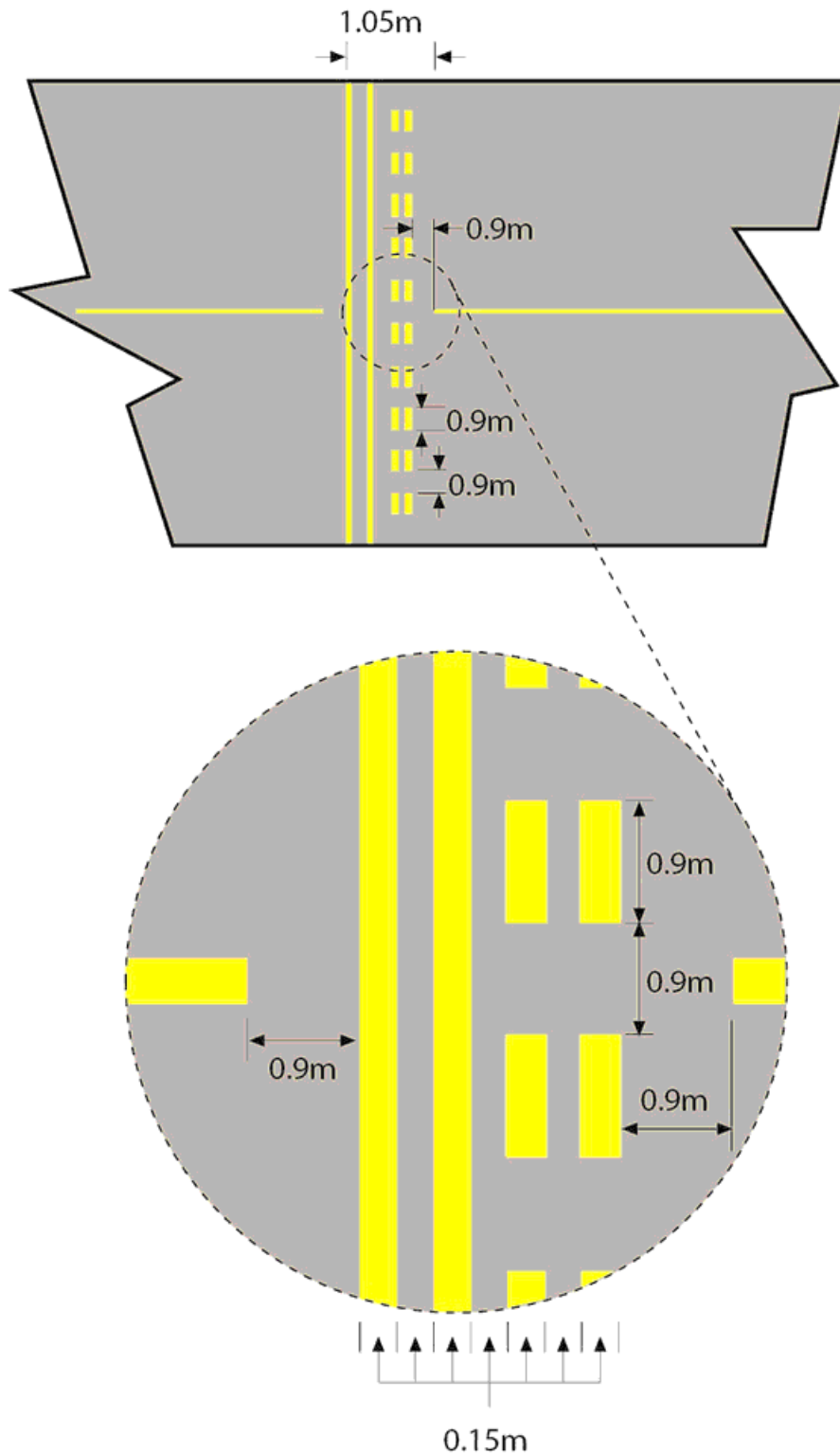

signify the designated visual holding position associated with a runway beyond which no part of a flying machine or vehicle must project in the direction of the runway without permission from the air traffic control unit at the aerodrome during the notified hours of watch of that unit.

(2) Outside the notified hours of watch of that unit or where there is no air traffic control unit at the aerodrome the markings referred to in paragraph (1) signify the position closest to the runway beyond which no part of a flying machine or vehicle must project in the direction of the runway

when the flying machine or vehicle is required to give way to aircraft which are taking off from or landing on that runway.

(3) Subject to paragraph (4), a marking, consisting of two yellow, parallel perpendicular lines intersected by horizontal yellow lines, as illustrated in the diagrams in this paragraph—

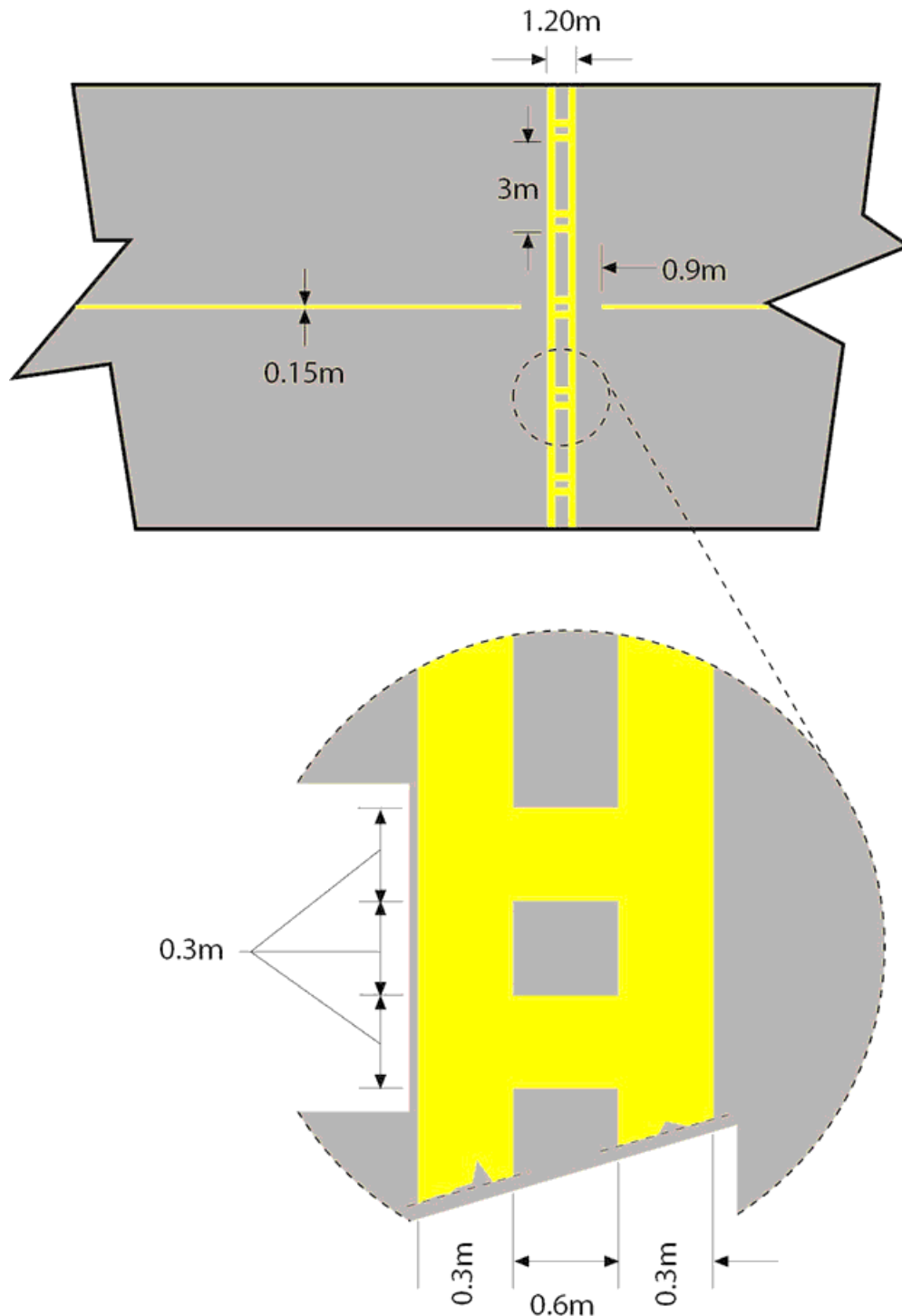

signifies a holding position other than that closest to the runway beyond which no part of a flying machine or vehicle must project in the direction of the runway without permission from the air traffic control unit at the aerodrome during the notified hours of watch of that unit.

(4) Outside the notified hours of watch of that unit or where there is no air traffic control unit at the aerodrome the marking referred to in paragraph (3) may be disregarded.

(5) Orange and white markers spaced not more than 15 metres apart, as illustrated in the diagram in this paragraph—

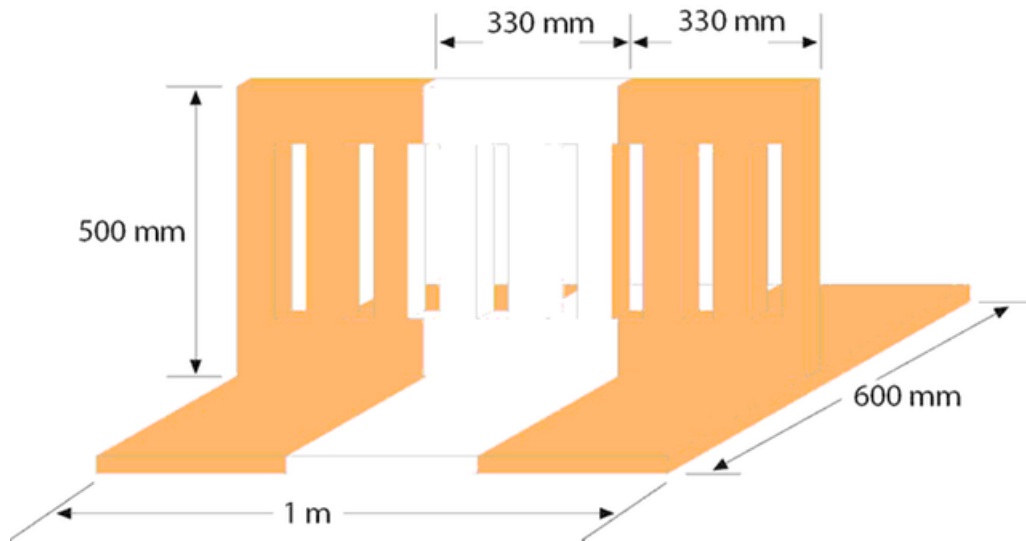

signify the boundary of that part of a paved runway, taxiway or apron which is unfit for the movement of aircraft.

Commencement

Sch. 1(5) para. 19(1)-(5): April 30, 2015

Extent

Sch. 1(5) para. 19(1)-(5): United Kingdom

✔ Law In Force

20.— Supplementary markings for use on unpaved manoeuvring areas

(1) Markers with orange and white stripes of an equal width of 50 centimetres, with an orange stripe at each end, alternating with flags 60 centimetres square showing equal orange and white triangular areas, spaced not more than 90 metres apart, as illustrated in the diagram in this paragraph—

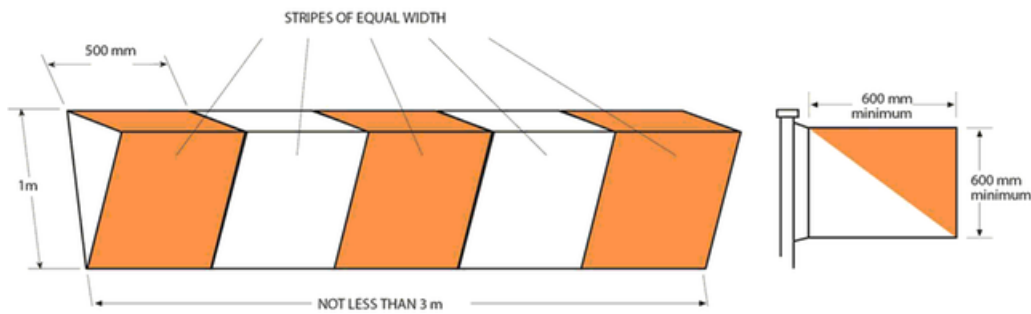

indicate the boundary of an area unfit for the movement of aircraft.

(2) Striped markers, as specified in paragraph (1), spaced not more than 45 metres apart, indicate the boundary of an aerodrome.

(3) On structures markers with orange and white vertical stripes, of an equal width of 50 centimetres, with an orange stripe at each end, spaced not more than 45 metres apart, as illustrated in the diagram in this paragraph—

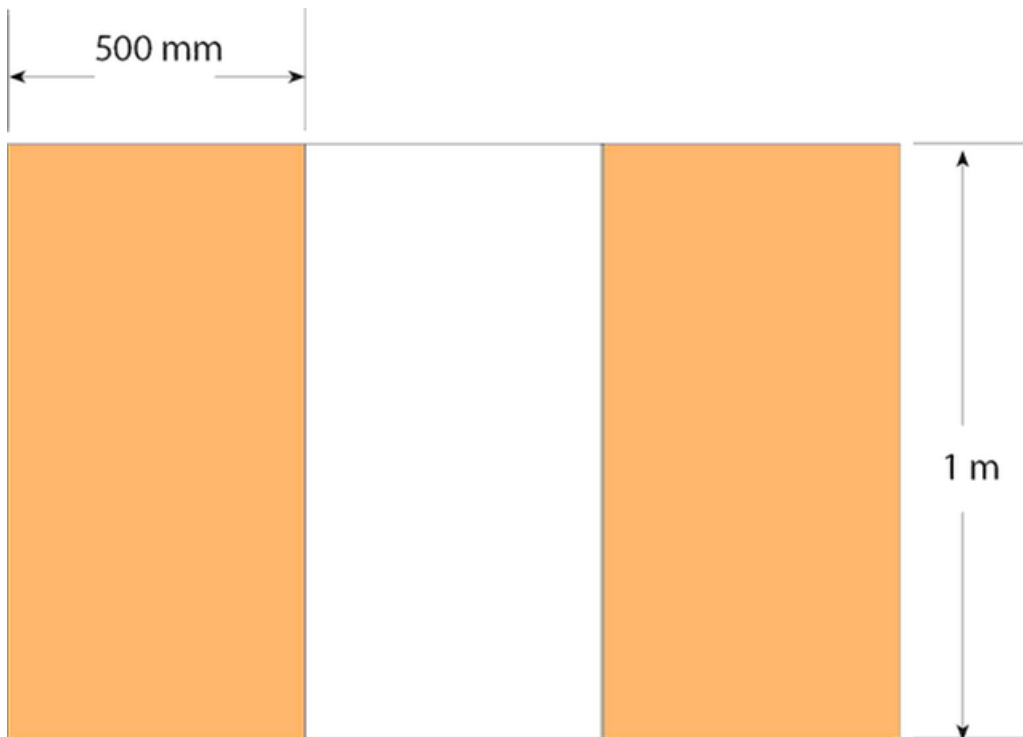

ORANGE

WHITE

ORANGE

indicate the boundary of an aerodrome.

(4) The pattern of the marker referred to in sub-paragraph (3) must be visible from inside and outside the aerodrome and the marker must be affixed not more than 15 centimetres from the top of the structure.

(5) White, flat, rectangular markers 3 metres long and 1 metre wide, at intervals not exceeding 90 metres, flush with the surface of an unpaved runway or stopway, indicate the boundary of the unpaved runway or stopway.

(6) A white letter H, as illustrated in the diagram in this paragraph—

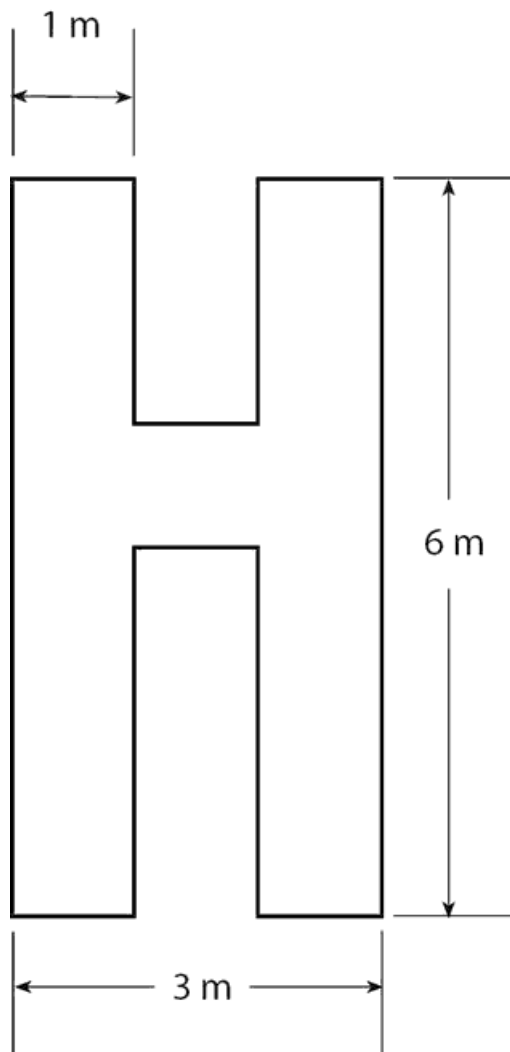

indicates an area which must be used only for the taking off and landing of helicopters.

(7) A yellow cross with two arms each 6 metres long by 1 metre wide at right angles, indicates that tow ropes, banners and similar articles towed by aircraft must only be picked up and dropped in the area in which the cross is placed.

(8) A white letter 'T', as specified in SERA, Appendix 1, paragraph 3.2.5.1, placed at the left-hand side of a runway (when viewed from the direction of landing), also indicates the runway to be used for take-off and landing.

Commencement

Sch. 1(5) para. 20(1)-(8): April 30, 2015

Extent

Sch. 1(5) para. 20(1)-(8): United Kingdom

✔ Law In Force

21. Signals visible from the ground

Black, Arabic numerals in two-figure groups and, where parallel runways are provided, the letter or letters L (left), LC (left centre), C (centre), RC (right centre) and R (right), placed against a yellow background, indicate the direction for take-off or the runway in use.

Commencement

Sch. 1(5) para. 21: April 30, 2015

Extent

Sch. 1(5) para. 21: United Kingdom

SECTION 6

VISUAL METEOROLOGICAL CONDITIONS, VISUAL FLIGHT RULES, SPECIAL VFR AND INSTRUMENT FLIGHT RULES

✔ Law In Force

22. Classification of airspaces and rules for flight

Subject to rule 23, all aircraft must be flown in accordance with the requirements for flight in airspace that have been notified in accordance with the airspace classifications and flight rules specified in SERA.6001 and in Appendix 4 of SERA.

Commencement

Sch. 1(6) para. 22: April 30, 2015

Extent

Sch. 1(6) para. 22: United Kingdom

✔ Law In Force

23.— Flight in Class C airspace in VMC

(1) Subject to paragraph (2), an aircraft flying in visual meteorological conditions—
(a) in Class C airspace above flight level 195; or
(b) along a Class C ATS route at any level,
must be flown in accordance with the instrument flight rules¹.

(2) Paragraph (1) does not apply to an aircraft which is flying in accordance with a permission issued by the CAA.

(3) In this rule “Class C ATS route” means a route notified as such.

Notes

¹ The instrument flight rules are prescribed by section 5 of SERA.

Commencement

Sch. 1(6) para. 23(1)-(3): April 30, 2015

Extent

Sch. 1(6) para. 23(1)-(3): United Kingdom

✔ Law In Force

24.— Use of radio navigation aids

(1) Subject to paragraph (2), the commander of an aircraft must not make use of a radio navigation aid without complying with such restrictions and procedures as may be notified in relation to that aid.

(2) The commander of an aircraft is not required to comply with this rule if—

- (a) the aircraft is required to comply with an air traffic control clearance issued for the flight; or
- (b) the commander is otherwise authorised by an air traffic control unit.

Commencement

Sch. 1(6) para. 24(1)-(2)(b): April 30, 2015

Extent

Sch. 1(6) para. 24(1)-(2)(b): United Kingdom

✔ Law In Force

25.— Air traffic control clearance for flights by aircraft without radio equipment

(1) An aircraft without radio equipment must not fly in Class B, Class C or Class D airspace during the notified hours of watch of the appropriate air traffic control unit unless it has been authorised to do so by that unit and complies with the conditions in paragraph (3).

(2) An aircraft without radio equipment and flown in accordance with the instrument flight rules must not fly in Class E airspace during the notified hours of watch of that unit unless it has been authorised to do so by the unit and complies with the conditions in paragraph (3).

(3) The conditions are that the aircraft must—

- (a) only fly during the day;

- (b) only fly within controlled airspace notified for the purpose of this paragraph;
- (c) remain at least 1,500 metres horizontally and 1,000 feet vertically away from cloud and in a flight visibility of at least 5 km; and
- (d) comply with any conditions or requirements specified by the appropriate air traffic control unit.

Commencement

Sch. 1(6) para. 25(1)-(3)(d): April 30, 2015

Extent

Sch. 1(6) para. 25(1)-(3)(d): United Kingdom

SCHEDULE 2

Revocations

Regulation 4

 Law In Force

<i>Regulations revoked</i>	<i>Reference</i>
The Rules of the Air Regulations 2007	S.I. 2007/734
The Rules of the Air (Amendment) Regulations 2007	S.I. 2007/1371
The Rules of the Air (Amendment) Regulations 2008	S.I. 2008/669
The Rules of the Air (Amendment) Regulations 2009	S.I. 2009/2169
The Rules of the Air (Amendment) Regulations 2010	S.I. 2010/841

Commencement

Sch. 2 para. 1: April 30, 2015

Extent

Sch. 2 para. 1: United Kingdom

EXPLANATORY NOTE

(This note is not part of the Rules)

These Regulations (“the 2015 Regulations”) introduce the Rules of the Air 2015 (“the 2015 Rules”) and revoke the Rules of the Air Regulations 2007 (S.I. 2007/734) (“the 2007 Regulations”) and the instruments that amend the 2007 Regulations.

The 2015 Regulations are made in consequence of the coming into force in the United Kingdom of Commission Implementing Regulation (EU) No. 923/2012 of the European Parliament and of the Council of 26 September 2012 laying down the common rules of the air and operational provisions regarding services and procedures in air navigation and amending Implementing Regulation (EU) No 1035/2011 and Regulations (EC) No 1265/2007, (EC) No 1794/2006, (EC) No 730/2006, (EC) No 1033/2006 and (EU) No 255/2010 (O.J. No.L281 of 13.10.2012, p.1) (“the SERA Regulation”).

The 2015 Rules supplement Annex 1 (“SERA”) of the SERA Regulation and should be read in conjunction with SERA. This is permitted by article 8 of the SERA Regulation which enables Member States to retain additional rules of the air providing they are consistent with a standard of the International Civil Aviation Organisation and do not constitute a difference under the Convention on International Civil Aviation and its Annexes signed on behalf of the Government of the United Kingdom on the 7th December 1944 at the International Civil Aviation Conference in Chicago.

Copies of the Convention and its Annexes may be purchased from the International Civil Aviation Organisation at this website: <http://store1.icao.int/> or from Airplan Flight Equipment Limited, 1a Ringway Trading Estate, Shadowmoss Road, Manchester M22 5LH; telephone 0161 499 0023; e-mail enquiries@afeonline.com; <http://www.afeonline.com>.

Copies of the United Kingdom Aeronautical Information Publication can be obtained from the UK Aeronautical Information Service, NATS Limited, 1st Floor, North Wing, Heathrow House, Bath Road, Hounslow, Middlesex TW5 9AT or viewed online at: http://www.nats-uk.ead-it.com/public/index.php%3Foption=com_content&task=blogcategory&id=1&Itemid=2.html.

The 2015 Rules, which follow the arrangement of SERA, therefore specify provisions from the 2007 Regulations which are not included in the SERA Regulation.

The 2015 Rules apply to all aircraft within the United Kingdom (other than military aircraft, as defined in article 255(1) of the Air Navigation Order 2009) and to all UK registered aircraft wherever they may be unless it is necessary for the pilot to depart from the Rules in order to avoid immediate danger, to comply with the law of any country over which the aircraft is being flown or to comply with Military Flying Regulations or Flying Orders to Contractors issued by the Secretary of State. (See articles 160(3) and 247(1)(a) of the Air Navigation Order 2009. Article 160(3) was amended by the Air Navigation (Amendment) (No. 4) Order 2014).

Section 3 of the 2015 Rules sets out requirements for collision avoidance and protection of persons and property. It also specifies supplementary markings for runways and taxiways.

Section 4 of the 2015 Rules sets out requirements for lights and signals to be displayed by aircraft, in relation to helicopters on an offshore or renewable energy installation, the failure of anti-collision or navigation lights and airships flying by day. These supplement SERA.3215.

Section 5 of the 2015 Rules sets out prohibitions for the misuse of signals and markings at an aerodrome and prescribes requirements for aerodrome markings which are additional to those prescribed in appendix 1 to SERA.

Section 6 of the 2015 Rules sets out requirements relating to visual flight and instrument flight rules. These supplement section 5 of SERA and SERA.6001.

Rule 22 requires aircraft to be flown in accordance with the requirements for flight in airspace that have been notified in accordance with the airspace classification and flight rules specified in SERA.6001 and appendix 4 of SERA. Airspace is classified and notified in the United Kingdom by the Civil Aviation Authority in the Aeronautical Information Publication.

Rule 23 requires aircraft to be flown in accordance with the instrument flight rules when flying in Class C airspace in visual meteorological conditions above flight level 195 or along a Class C ATS route at any level. This is a requirement under article 3 of Commission Regulation (EC) No 730/2006 (O.J. L. 128 of 16.05.2006, p.3) and which is subject to article 4 of that Regulation.

Rule 25 prohibits aircraft not equipped with radio equipment from flying in class B, C, D or E airspace unless it has been authorised by the appropriate air traffic control unit and subject to further conditions specified in that rule.

It is an offence under articles 160(2) and 241(6) of, and Part B of Schedule 13 to, the Air Navigation Order 2009 to contravene any of the 2015 Rules. The offences are punishable on summary conviction by a fine not exceeding level 4 on the standard scale. Part B of Schedule 13 to the Air Navigation Order 2009 was amended by the Air Navigation (Amendment) (No. 4) Order 2014.

Regulation 3 requires the Secretary of State to review the operation and effect of the 2015 Rules and to publish a report by the fifth anniversary of their coming into force, setting out the conclusions of the review, and every five years thereafter. Following a review it will fall to the Secretary of State to consider whether the 2015 Rules should remain as they are or whether they should be amended or revoked. A further instrument would be needed to amend or revoke the 2015 Rules.

A full regulatory impact assessment of the effect that this instrument will have on the costs of business and the voluntary sector is available and is published with the Explanatory Memorandum alongside this instrument at www.legislation.gov.uk.

Table of Contents

Rules of the Air Regulations 2015/840.....	<u>1</u>
Preamble	<u>1</u>
✓ reg. 1 Citation and commencement.....	<u>1</u>
✓ reg. 2 Rules of the Air.....	<u>1</u>
✓ reg. 3 Review.....	<u>2</u>
✓ reg. 4 Revocation.....	<u>2</u>
✓ Signatures	<u>2</u>
Schedule 1 The Rules of the Air Regulations 2015.....	<u>3</u>
Part 1 INTERPRETATION.....	<u>3</u>
✓ para. 1 Interpretation.....	<u>3</u>
Part 2 APPLICATION AND COMPLIANCE.....	<u>4</u>
✓ para. 2 Application of Rules to aircraft.....	<u>4</u>
✓ para. 3 Permissions.....	<u>4</u>
Part 3 GENERAL RULES, COLLISION AVOIDANCE AND PROTECTION OF PERSONS AND PROPERTY.....	<u>5</u>
✓ para. 4 Aerobatic flights.....	<u>5</u>
✓ para. 5 Landing and taking off within congested areas and near open-air assemblies..	<u>5</u>
✓ para. 6 Test flying over congested areas.....	<u>6</u>
✓ para. 7 Launching, picking up and dropping of tow ropes, etc.....	<u>6</u>
✓ para. 8 Avoiding aerial collisions.....	<u>7</u>
✓ para. 9 Order of landing.....	<u>7</u>
✓ para. 10 Landing and take-off.....	<u>8</u>
✓ para. 11 Flight within aerodrome traffic zones.....	<u>8</u>
✓ para. 12 Movement of aircraft on uncontrolled aerodromes.....	<u>9</u>
✓ para. 13 Access to and movement of persons and vehicles on the aerodrome.....	<u>10</u>
Part 4 LIGHTS TO BE DISPLAYED BY AIRCRAFT.....	<u>10</u>
✓ para. 14 Stationary helicopters on offshore or renewable energy installations.....	<u>10</u>
✓ para. 15 Failure of anti-collision and navigation lights.....	<u>11</u>
✓ para. 16 Airships by day.....	<u>11</u>
Part 5 AERODROME VISUAL SIGNALS AND MARKINGS.....	<u>11</u>
✓ para. 17 Aerodrome Visual Signals and Markings.....	<u>12</u>
✓ para. 18 Misuse of signals and markings.....	<u>12</u>
✓ para. 19 Markings for paved runways and taxiways.....	<u>12</u>
✓ para. 20 Supplementary markings for use on unpaved manoeuvring areas.....	<u>15</u>
✓ para. 21 Signals visible from the ground.....	<u>18</u>
Part 6 VISUAL METEOROLOGICAL CONDITIONS, VISUAL FLIGHT RULES, SPECIAL VFR AND INSTRUMENT FLIGHT RULES.....	<u>18</u>
✓ para. 22 Classification of airspaces and rules for flight.....	<u>18</u>

✓ para. 23 Flight in Class C airspace in VMC.....	<u>18</u>
✓ para. 24 Use of radio navigation aids.....	<u>19</u>
✓ para. 25 Air traffic control clearance for flights by aircraft without radio equipment.....	<u>19</u>
Schedule 2 Revocations.....	<u>20</u>
✓ para. 1	<u>20</u>
Explanatory Note	<u>20</u>
para. 1	<u>21</u>
Table of Contents.....	<u>23</u>